

大连奇耘电子有限公司
DALIAN QIYUN DISPLAY CO., LTD.

DESIGNED BY:

WCL

GDC04789T(P)-12

VERSION: 2.0

NO. 2 OF 4

CHECKED BY:

DJH

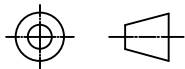

UNIT: mm

DATE: 2016-02-26



TOLERANCES UNLESS OTHERWISE SPECIFIED: ±0.2

全显示效果图

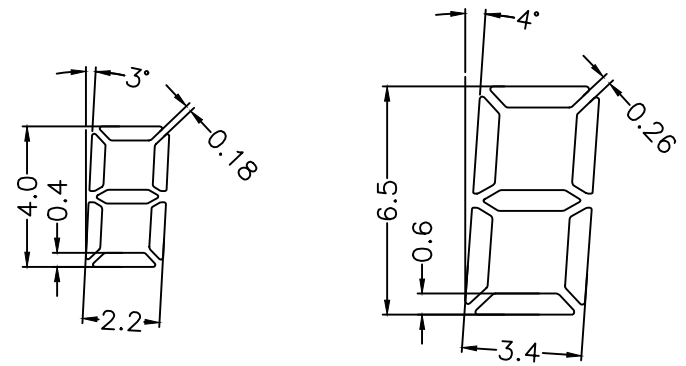
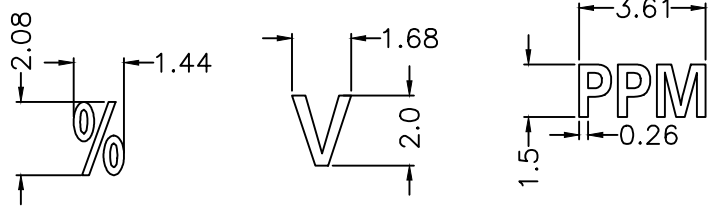
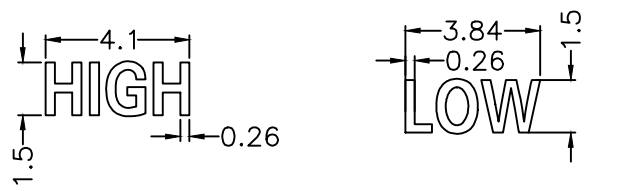
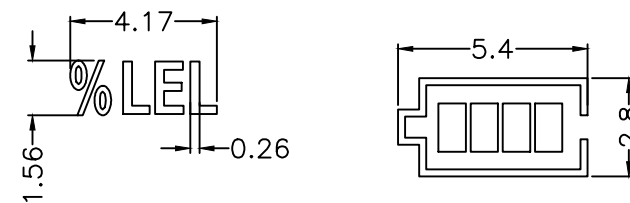
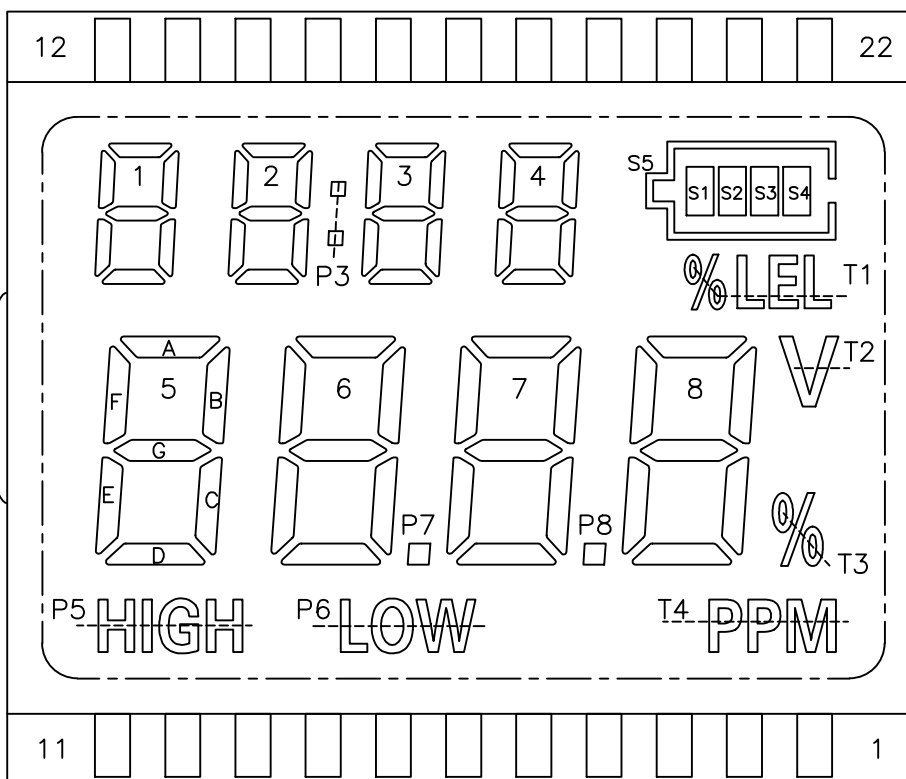
PIN	1	2	3	4	5	6	7	8	9	10	11	12	13	14	15	16	17	18	19	20	21	22
COM1	COM1				8A	8F	7A	7F	6A	6F	5A	5F		1D		2D	S1	3D	S2	4D	P3	T1
COM2		COM2			8B	8G	7B	7G	6B	6G	5B	5G	1E	1C	2E	2C	3E	3C	4E	4C	S5	T2
COM3			COM3		8C	8E	7C	7E	6C	6E	5C	5E	1G	1B	2G	2B	3G	3B	4G	4B	S4	T3
COM4				COM4	8D	P8	7D	P7	6D	P6	5D	P5	1F	1A	2F	2A	3F	3A	4F	4A	S3	T4



 **大连奇耘电子有限公司**
DALIAN QIYUN DISPLAY CO., LTD.

DESIGNED BY: WCL	GDC04789T(P)-12	VERSION: 2.0 NO. 3 OF 4
CHECKED BY: DJH	 	UNIT: mm DATE: 2016-02-26
TOLERANCES UNLESS OTHERWISE SPECIFIED: ±0.2		

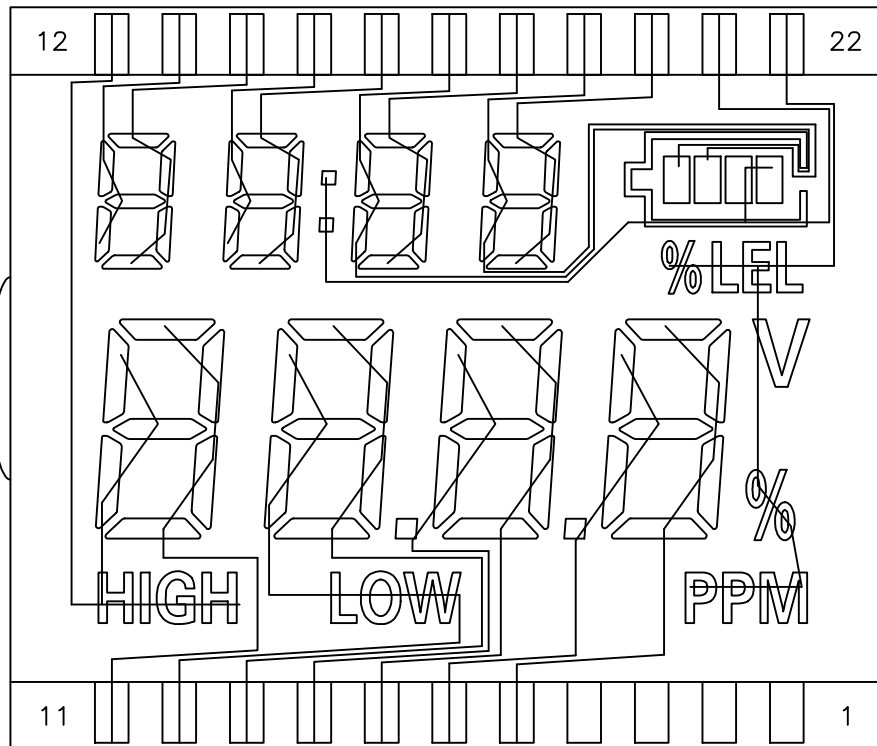

SEG

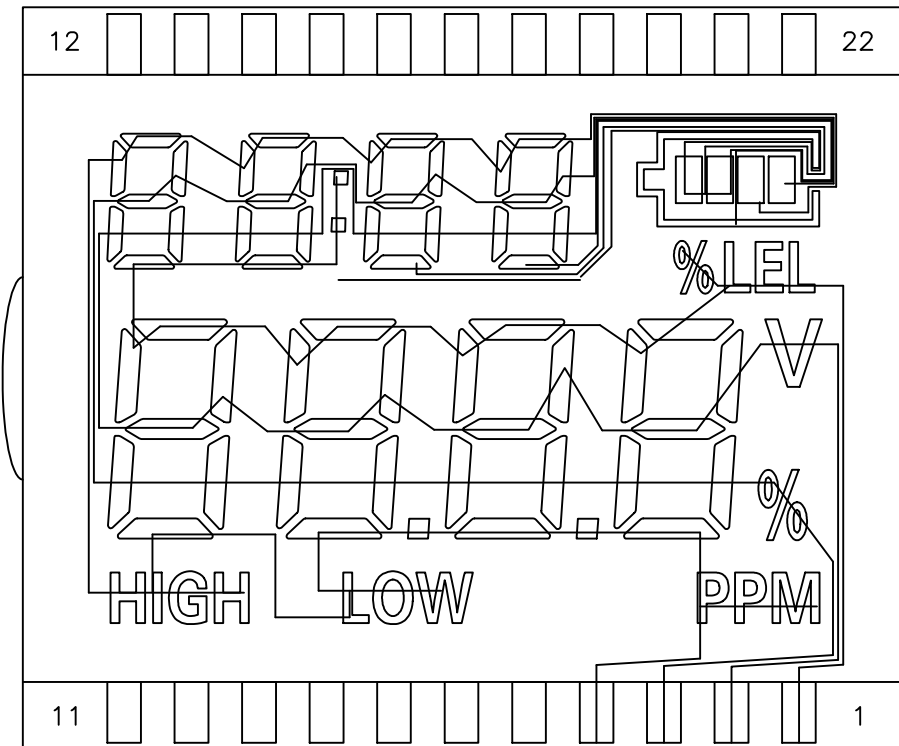

COM

 **大连奇耘电子有限公司**
DALIAN QIYUN DISPLAY CO., LTD.

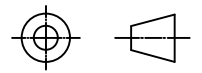
DESIGNED BY: WCL	GDC04789T(P)-12	VERSION: 2.0 NO. 4 OF 4
CHECKED BY: DJH		UNIT: mm DATE: 2016-02-26
TOLERANCES UNLESS OTHERWISE SPECIFIED: ±0.2		